

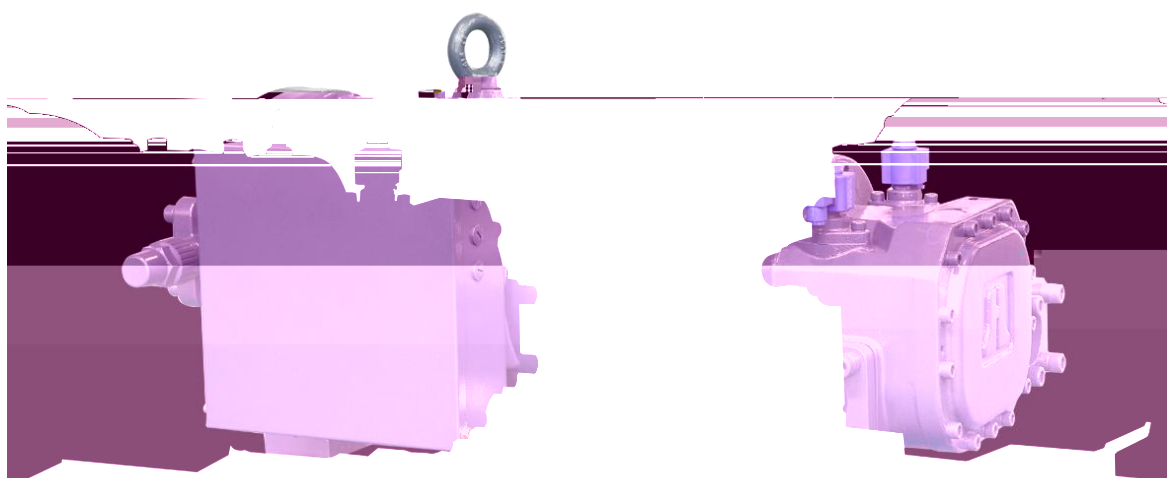

RH



RH

CO<sub>2</sub>

-28

单

CO<sub>2</sub>

,

30bar

R744(CO<sub>2</sub>)

RH

RH

RH

等

RH

CO<sub>2</sub>

NH<sub>3</sub> R134a R507A

点

单

/

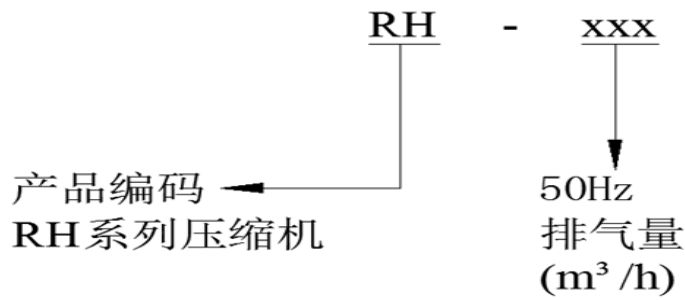

等



单



单



PT100\PT1000\NTC



RH

63bar

45bar

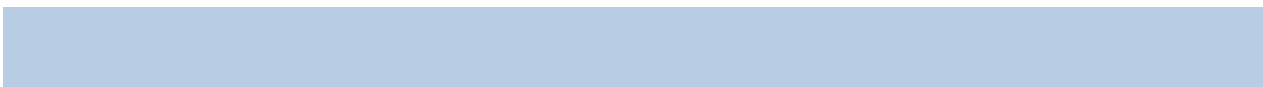

RH

R410A

R134A

	50Hz	50Hz r/min	冻		dB
	m <sup>3</sup> /h				
RH-150	150	2950	33%/66% 100%		75
RH-300	300		25%/50% 75%/100%		78
RH-550	550				81
RH-850	850		84		

2-3.RH

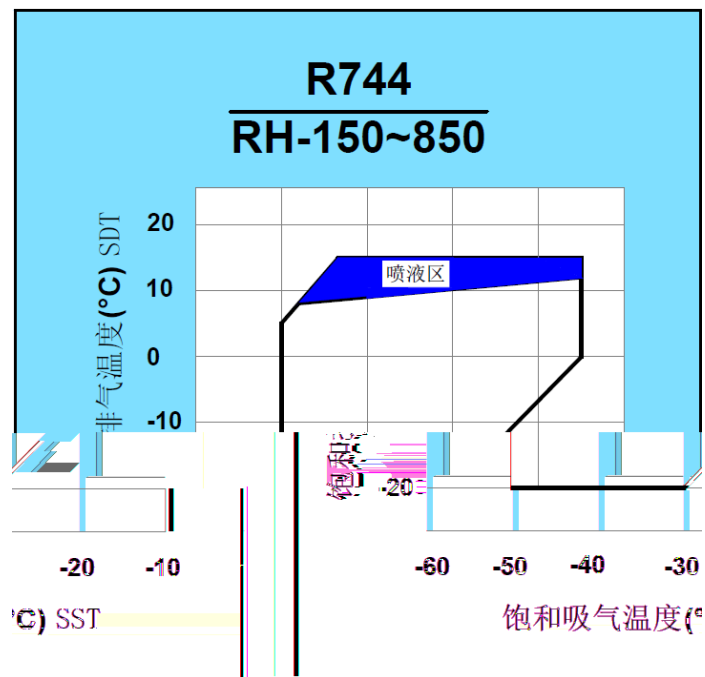

R744

## RH-150

RH150 ,R744 , ECO SH/SC:5/5									
		-50.00	-45.00	-40.00	-35.00	-30.00	-25.00	-20.00	-15.00
-20.00	(kW)	190.20	235.14	285.05	346.56	418.27			
	(kW)	241.28	285.12	330.41	385.34	447.55			
	(kW)	51.07	49.98	45.36	38.77	29.28			
	(A)	86.22	84.38	76.58	65.46	49.44			
	(KW)	0.00	0.00	0.00	0.00	0.00			
		3.72	4.70	6.28	8.94	14.28			
-15.00	(kW)	175.78	217.45	265.20	333.49	389.29	466.92	553.78	
	(kW)	233.06	274.90	318.96	383.41	433.00	500.28	572.08	
	(kW)	57.28	57.45	53.76	49.92	43.71	33.36	18.30	
	(A)	96.70	96.99	90.76	84.27	73.79	56.32	30.90	
	(KW)	0.00	0.00	0.00	0.00	0.00	0.00	0.00	
		3.07	3.78	4.93	6.68	8.91	14.00	30.26	
-5.00	(kW)	148.43	184.03	227.31	266.47	334.42	401.35	481.59	574.70
	(kW)	218.45	253.94	298.01	337.63	399.78	461.25	533.09	613.86
	(kW)	70.02	69.92	70.70	71.17	65.36	59.90	51.50	39.16
	(A)	118.21	118.04	119.36	120.14	110.33	101.12	86.94	66.11
	(KW)	21.35	9.04	0.00	0.00	0.00	0.00	0.00	0.00
		2.12	2.63	3.21	3.74	5.12	6.70	9.35	14.67
5.00	(kW)	123.86	154.94	191.85	233.92	282.97	339.83	408.16	487.47
	(kW)	208.70	240.06	277.17	318.13	365.36	420.81	485.64	558.27
	(kW)	84.84	85.12	85.32	84.21	82.39	80.99	77.47	70.79
	(A)	143.23	143.70	144.04	142.17	139.10	136.73	130.79	119.51
	(KW)	46.28	35.79	23.29	7.60	0.00	0.00	0.00	0.00
		1.46	1.82	2.25	2.78	3.43	4.20	5.27	6.89
10.00	(kW)		142.01	174.84	213.39	258.32	310.40	370.67	440.16
	(kW)		237.98	269.86	306.31	349.24	400.31	457.32	520.98
	(kW)		95.97	95.02	92.92	90.92	89.91	86.65	80.82
	(A)		162.02	160.41	156.86	153.50	151.78	146.28	136.44
	(KW)		52.49	40.13	24.53	6.74	0.00	0.00	0.00
			1.48	1.84	2.30	2.84	3.45	4.28	5.45
15.00	(kW)			158.52	193.45	234.30	281.71	334.24	394.37
	(kW)			258.40	295.47	335.29	381.62	431.91	487.49
	(kW)			99.88	102.02	100.99	99.91	97.67	93.13
	(A)			168.62	172.23	170.50	168.66	164.89	157.22
	(KW)			51.54	41.98	26.72	8.87	0.00	0.00
				1.59	1.90	2.32	2.82	3.42	4.23

RH-150

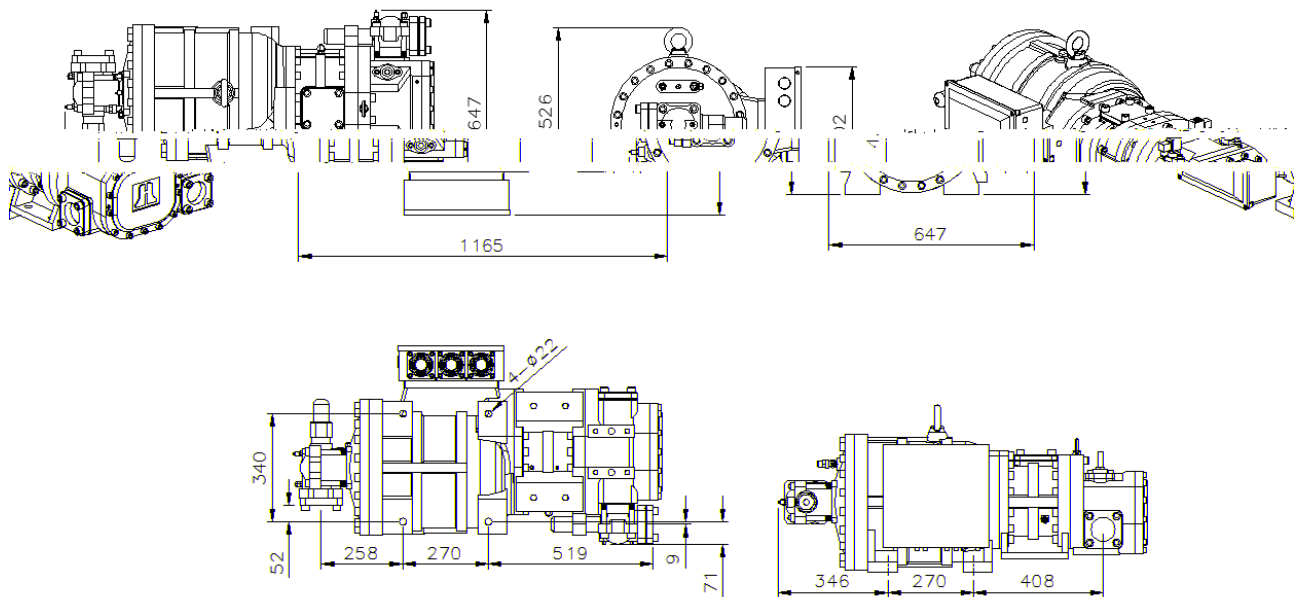

RH-150

)

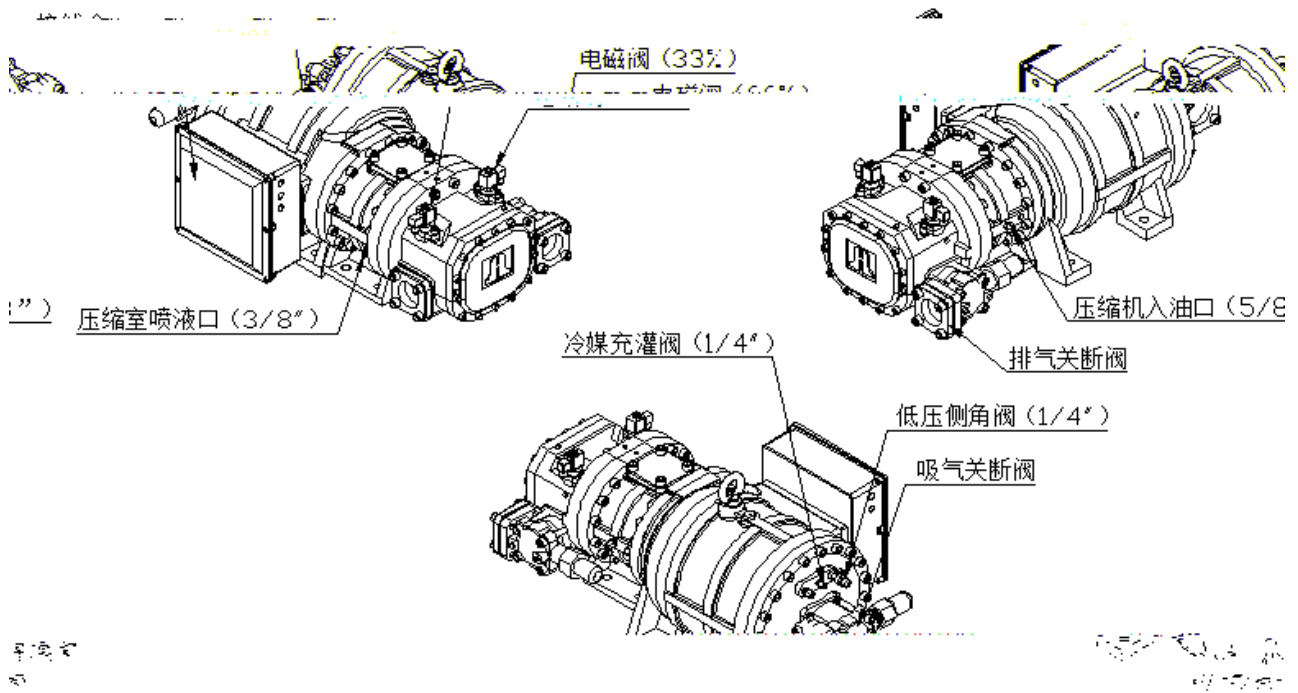

RH-150

				A	B	C	D	E
RH150			2 1/8"	50	90	30	55	65
			2"				61.3	74
				2 5/8"	60	110	35	68

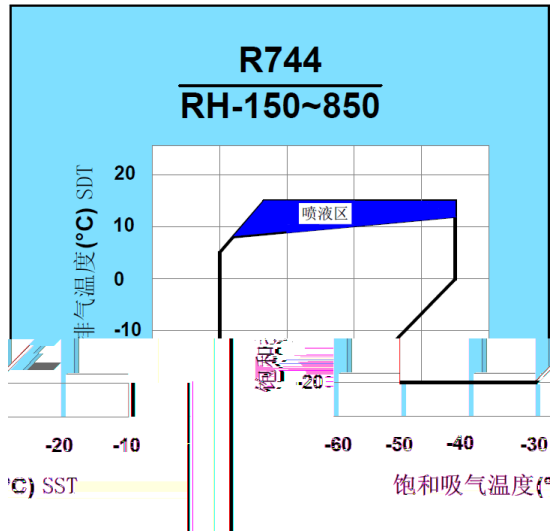

SHANGHAI HANBELL PRECISE MACHINERY CO., LTD  
8289

[http //www.hanbell.com.cn](http://www.hanbell.com.cn)

TEL 0531-85060075      2222      U      4  
FAX 0531-85060071

TEL 025--52078091/1/3      1001      U      6  
FAX 025-52078090

TEL 020-34721075      FAX 020-3472325      15

TEL 023-62611068      18      F      1-1  
FAX 023-62611069